

RECINZIONI



LA STORIA

Alfredo Vavassori inizia, nei primi anni '60, la produzione di reti a maglia sciolta zincata e plastificata, alla quale presto si affianca anche la commercializzazione di filo cotto e zincato, di chiodi e di una serie di articoli legati all'edilizia e alle recinzioni.

Negli anni seguenti, la continua evoluzione dell'impresa permette di affiancare alla produzione di reti anche quella di una parte di articoli che prima venivano solo commercializzati.

Una continua crescita, che ha portato a trasformare l'attività artigianale di ieri nelle attuali TRAFILERIE VAVASSORI s.r.l.

OGGI

TRAFILERIE VAVASSORI s.r.l. producono filo trafilato, filo zincato, filo cotto nero e bianco, filo lucido in confezioni prepesate (da 5 kg sino a matassoni da 1000 kg); chiodi di tutte le misure, lucidi, zincati elettroliticamente e a caldo; filo plastificato in varie confezioni (dalle matassine da 10 metri per il "fai da te", sino ai matassoni per uso industriale da 500 kg) e rete metallica a maglia sciolta, sia zincata che plastificata.

L'intera produzione viene realizzata con macchinari all'avanguardia per garantire sempre la massima qualità.

TRAFILERIE VAVASSORI s.r.l. hanno affiancato, alla produzione, la commercializzazione di una vasta gamma di articoli per edilizia.

CERTIFICAZIONI

TRAFILERIE VAVASSORI s.r.l. sono certificate secondo le normative UNI EN ISO 9001:2015.

Il Sistema di Gestione della Qualità è finalizzato nel miglioramento continuo delle attività aziendali adeguandole alle richieste della Clientela.

TRAFILERIE VAVASSORI s.r.l. - per dare valore aggiunto all'azienda e, di conseguenza, alla Clientela - hanno scelto di sviluppare un Sistema di Gestione della Qualità secondo la Norma ISO 9001:2015.

La qualità dei processi produttivi e dell'organizzazione aziendale, abbinata a una costante evoluzione degli strumenti operativi e alla formazione delle risorse umane, permette di garantire prodotti di "Qualità Vavassori".



SISTEMA DI GESTIONE
QUALITÀ CERTIFICATO







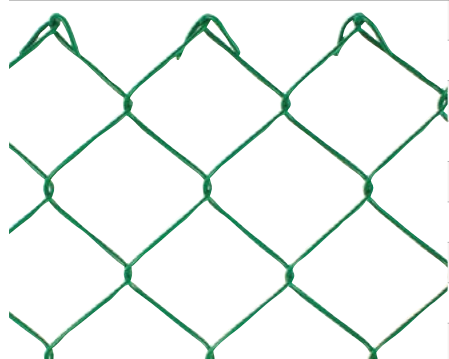

UNI EN ISO 9001:2015

RECINZIONI

FREEPLAST LEGGERA



Peso al mq: kg 1,000 ca.





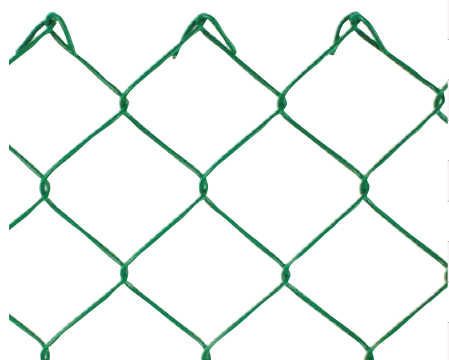

Articolo		 Ø mm	 cm	 ml	 kg rotolo	 rotoli per bancale	€ rotolo
2RP260080	50x50	1,85/2,60	80	25	20,00	12	71,65
2RP260100	50x50	1,85/2,60	100	25	25,00	12	89,09
2RP260125	50x50	1,85/2,60	125	25	31,25	12	110,89
2RP260150	50x50	1,85/2,60	150	25	37,50	12	134,98
2RP260175	50x50	1,85/2,60	175	25	43,75	12	157,12
2RP260200	50x50	1,85/2,60	200	25	50,00	12	179,50
2RP260H080MT10	50x50	1,85/2,60	80	10	8,00	30	31,79
2RP260H100MT10	50x50	1,85/2,60	100	10	10,00	30	39,47
2RP260H125MT10	50x50	1,85/2,60	125	10	12,50	30	49,08
2RP260H150MT10	50x50	1,85/2,60	150	10	15,00	30	59,63
2RP260H175MT10	50x50	1,85/2,60	175	10	17,50	30	69,37
2RP260H200MT10	50x50	1,85/2,60	200	10	20,00	30	79,21

Colore: verde

FREEPLAST MEDIA



Peso al mq: kg 1,200 ca.





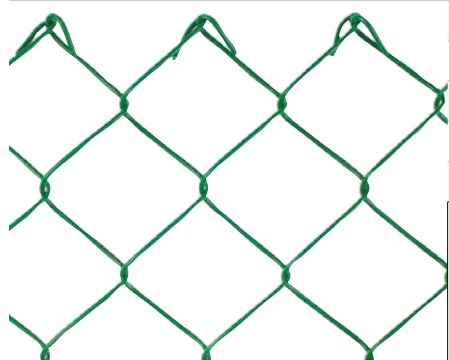

Articolo		 Ø mm	 cm	 ml	 kg rotolo	 rotoli per bancale	€ rotolo
2RP280080	50x50	2,00/2,80	80	25	24,00	12	80,41
2RP280100	50x50	2,00/2,80	100	25	30,00	12	100,04
2RP280125	50x50	2,00/2,80	125	25	37,50	12	124,58
2RP280150	50x50	2,00/2,80	150	25	45,00	12	151,41
2RP280175	50x50	2,00/2,80	175	25	52,50	12	176,28
2RP280200	50x50	2,00/2,80	200	25	60,00	12	201,40
2RP280H080MT10	50x50	2,00/2,80	80	10	9,60	30	35,42
2RP280H100MT10	50x50	2,00/2,80	100	10	12,00	30	44,01
2RP280H125MT10	50x50	2,00/2,80	125	10	15,00	30	54,74
2RP280H150MT10	50x50	2,00/2,80	150	10	18,00	30	66,43
2RP280H175MT10	50x50	2,00/2,80	175	10	21,00	30	77,30
2RP280H200MT10	50x50	2,00/2,80	200	10	24,00	30	88,27

Colore: verde - Colore: antracite - 10 punti dallo sconto base

FREEPLAST PESANTE



Peso al mq: kg 1,400 ca.





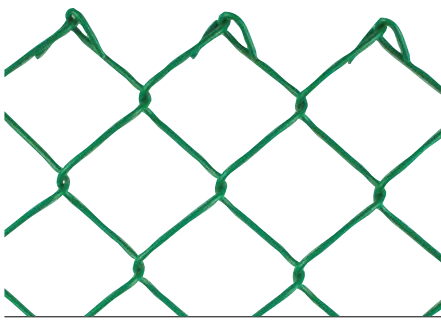

Articolo		 Ø mm	 cm	 ml	 kg rotolo	 rotoli per bancale	€ rotolo
2RP300100	50x50	2,15/3,00	100	25	35,00	12	114,80
2RP300125	50x50	2,15/3,00	125	25	43,75	12	143,03
2RP300150	50x50	2,15/3,00	150	25	52,50	12	173,55
2RP300175	50x50	2,15/3,00	175	25	61,25	12	202,12
2RP300200	50x50	2,15/3,00	200	25	70,00	12	230,92

Colore: verde

RECINZIONI

FREEPLAST SUPER 48x48









Articolo	 48x48	 Ø mm	 cm	 ml	 kg mq	 rotoli per bancale	€ kg
2RPK3004848	48x48	2,20/3,00	50-300	12,5	1,55	12	4,46
2RPK3204848	48x48	2,40/3,20	50-300	12,5	1,90	12	4,32
2RPK3404848	48x48	2,70/3,40	50-300	12,5	2,40	12	4,14
2RPK4004848	48x48	3,00/4,00	50-300	12,5	3,00	12	4,06

Colore: verde - Colore: antracite/bianco/marrone - 10 punti dallo sconto base

FREEPLAST SUPER 30x30







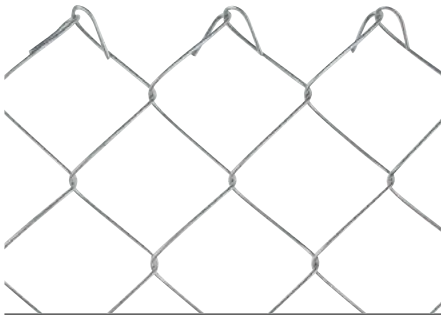

Articolo	 30x30	 Ø mm	 cm	 ml	 kg mq	 rotoli per bancale	€ kg
2RP3030	30x30	2,00/2,80	50-200	12,5	2,20	12	4,64

Colore: verde

Su richiesta per rot 40 si produce fino a cm 300

FREENET 13







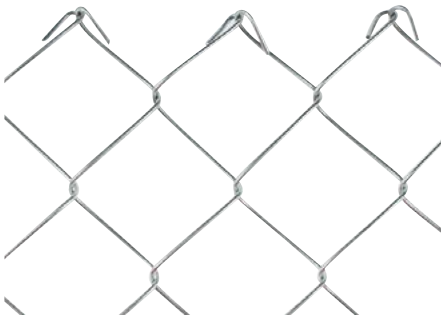

Articolo	 50x50	 Ø mm	 cm	 ml	 kg rotolo	 rotoli per bancale	€ rotolo
2RZ13100	50x50	2,00	100	25	24,00	12	78,12
2RZ13125	50x50	2,00	125	25	30,00	12	97,33
2RZ13150	50x50	2,00	150	25	36,00	12	117,20
2RZ13175	50x50	2,00	175	25	42,00	12	136,60
2RZ13200	50x50	2,00	200	25	48,00	12	156,11

Finitura: zincata a caldo

Peso al mq: kg 0,960 ca.

FREENET 14









Articolo	 50x50	 Ø mm	 cm	 ml	 kg rotolo	 rotoli per bancale	€ rotolo
2RZ14100	50x50	2,15	100	25	30,00	12	93,78
2RZ14125	50x50	2,15	125	25	37,50	12	116,90
2RZ14150	50x50	2,15	150	25	45,00	12	140,69
2RZ14175	50x50	2,15	175	25	52,50	12	164,00
2RZ14200	50x50	2,15	200	25	60,00	12	187,43

Finitura: zincata a caldo

Peso al mq: kg 1,200 ca.

FREENET SUPER 48x48







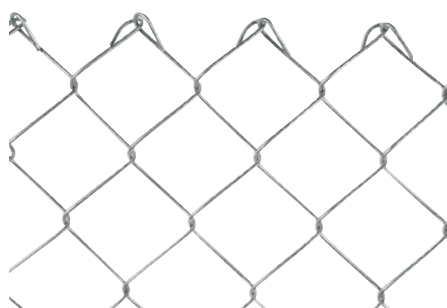

Articolo							€ kg
	Ø mm	cm	ml	kg mq	rotoli per bancale		
2RZK144848	48x48	2,20	50-300	12,5	1,35	12	3,53
2RZK154848	48x48	2,40	50-300	12,5	1,65	12	3,36
2RZK164848	48x48	2,70	50-300	12,5	2,10	12	3,20
2RZK174848	48x48	3,00	50-300	12,5	2,70	12	3,07

Finitura: zincata a caldo

FREENET SUPER 30x30







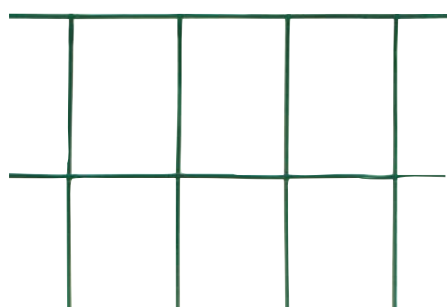

Articolo							€ kg
	Ø mm	cm	ml	kg mq	rotoli per bancale		
2RZK143030	30x30	2,20	50-200	12,50	2,15	12	3,55
2RZK173030	30x30	3,00	50-200	12,50	4,20	12	3,08

Finitura: zincata a caldo

Su richiesta per rot 40 si produce fino a cm 300







HOBBYPLAST 50x75

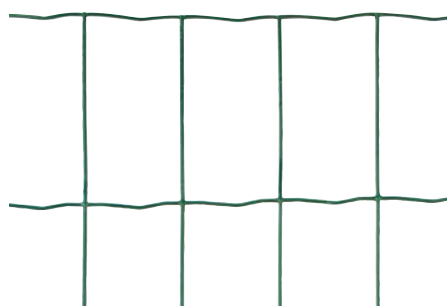

Articolo							€ rotolo
	Ø mm	cm	ml	kg rotolo	rotoli per bancale		
3EP5075080	50x75	2,40	80	25	16,20	12	86,34
3EP5075100	50x75	2,40	100	25	19,40	12	104,76
3EP5075120	50x75	2,40	125	25	24,40	12	130,94
3EP5075150	50x75	2,40	150	25	29,60	12	157,14
3EP5075180	50x75	2,40	175	25	34,40	12	183,32
3EP5075200	50x75	2,40	200	25	39,80	12	209,52

EUROPLAST 50x100







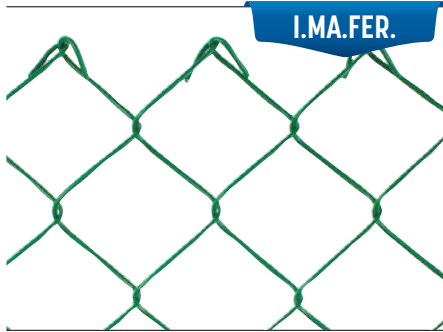

Articolo							€ rotolo
	Ø mm	cm	ml	kg rotolo	rotoli per bancale		
3EPL50100060	50x100	2,20	60	25	7,80	20	48,05
3EPL50100080	50x100	2,20	80	25	10,60	20	62,84
3EPL50100100	50x100	2,20	100	25	13,20	16	76,24
3EPL50100120	50x100	2,20	120	25	15,80	16	91,49
3EPL50100150	50x100	2,20	150	25	19,40	16	114,36
3EPL50100180	50x100	2,20	180	25	23,20	16	137,22
3EPL50100200	50x100	2,20	200	25	25,60	16	152,47

RECINZIONI

RETE PLASTICATA MAGLIA SCIOLTA



I.MA.FER.







Articolo		 Ø mm	 cm	 ml	 kg rotolo	 rotoli per bancale	€ rotolo
4RP250100	50x50	1,60-2,50	100	25	20,00	20	71,91
4RP250125	50x50	1,60-2,50	125	25	25,00	20	89,89
4RP250150	50x50	1,60-2,50	150	25	30,00	20	107,87
4RP250175	50x50	1,60-2,50	175	25	35,00	20	125,85
4RP250200	50x50	1,60-2,50	200	25	40,00	20	143,82

Peso al mq: kg 0,800 ca.

RETE ELETTROSALDATA ZINCATA E PLASTIFICATA







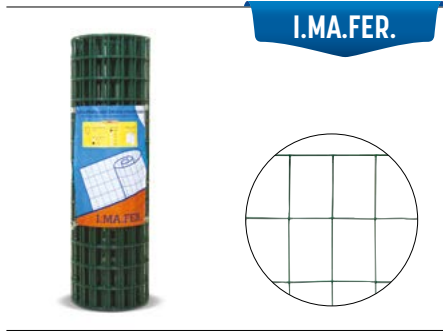

I.MA.FER.

Articolo		 Ø mm	 cm	 ml	 kg rotolo	 rotoli per bancale	€ rotolo
4EP5075100	50x75	1,80-2,40	100	25	18,50	12	84,94
4EP5075125	50x75	1,80-2,40	125	25	21,00	12	106,18
4EP5075150	50x75	1,80-2,40	150	25	27,30	12	127,41
4EP5075175	50x75	1,80-2,40	175	25	32,20	12	148,65
4EP5075200	50x75	1,80-2,40	200	25	36,30	12	169,88

RETE ELETTROSALDATA ZINCATA E PLASTIFICATA



I.MA.FER.





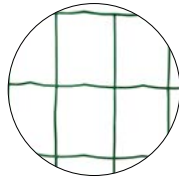

Articolo		 Ø mm	 cm	 ml	 kg rotolo	 rotoli per bancale	€ rotolo
4EPL5075100	50x75	1,70-2,10	100	25	15,50	16	64,86
4EPL5075125	50x75	1,70-2,10	125	25	18,60	16	81,08
4EPL5075150	50x75	1,70-2,10	150	25	23,50	16	97,29
4EPL5075175	50x75	1,70-2,10	175	25	26,50	16	113,51
4EPL5075200	50x75	1,70-2,10	200	25	29,50	16	129,52
4EPL5075H100MT10	50x75	1,70-2,10	100	10	6,10	-	31,24
4EPL5075H125MT10	50x75	1,70-2,10	125	10	7,40	-	39,05
4EPL5075H150MT10	50x75	1,70-2,10	150	10	9,25	-	46,86
4EPL5075H175MT10	50x75	1,70-2,10	175	10	10,80	-	54,67
4EPL5075H200MT10	50x75	1,70-2,10	200	10	12,35	-	62,48

RECINZIONI

RETE ELETTRISALDATA ZINCATA E PLASTIFICATA







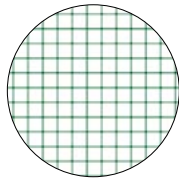

I.MA.FER.

Articolo		 Ø mm	 cm	 ml	 kg rotolo	 rotoli per bancale	€ rotolo
4EP6075100	60x75	1,70-2,20	100	25	14,50	16	59,07
4EP6075125	60x75	1,70-2,20	125	25	17,00	16	66,79
4EP6075150	60x75	1,70-2,20	150	25	21,50	16	80,15
4EP6075175	60x75	1,70-2,20	175	25	24,00	16	100,00
4EP6075200	60x75	1,70-2,20	200	25	28,50	16	110,42

RETE ELETTRISALDATA ZINCATA E PLASTIFICATA







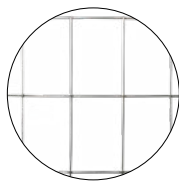

I.MA.FER.

Articolo		 Ø mm	 cm	 ml	 kg rotolo	 rotoli per bancale	€ rotolo
4EP1313050	13x13	0,80-1,20	50	25	10,00	20	36,06
4EP1313060	13x13	0,80-1,20	60	25	12,50	20	41,50
4EP1313080	13x13	0,80-1,20	80	25	15,50	20	54,73
4EP1313100	13x13	0,80-1,20	100	25	21,00	20	62,76
4EP1313120	13x13	0,80-1,20	120	25	24,50	20	74,83
4EP1313150	13x13	0,80-1,20	150	25	30,00	20	97,47

RETE ELETTRISALDATA ZINCATA PRIMA







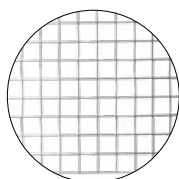

I.MA.FER.

Articolo		 Ø mm	 cm	 ml	 kg rotolo	 rotoli per bancale	€ rotolo
4EZ5075100	50x75	1,60	100	25	13,50	16	50,40
4EZ5075125	50x75	1,60	125	25	16,50	16	63,00
4EZ5075150	50x75	1,60	150	25	20,00	16	75,60
4EZ5075175	50x75	1,60	175	25	23,00	16	88,20
4EZ5075200	50x75	1,60	200	25	26,50	16	100,80

RETE ELETTRISALDATA ZINCATA DOPO







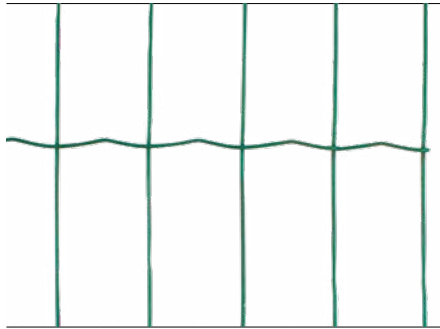

I.MA.FER.

Articolo		 Ø mm	 cm	 ml	 kg rotolo	 rotoli per bancale	€ rotolo
4EZD1313050	13x13	1,00	50	25	10	20	52,88
4EZD1313060	13x13	1,00	60	25	12	20	59,85
4EZD1313080	13x13	1,00	80	25	15,5	20	81,30
4EZD1313100	13x13	1,00	100	25	20,5	20	96,80
4EZD1313125	13x13	1,00	125	25	26,5	20	120,54
4EZD1313150	13x13	1,00	150	25	31	20	146,70

RECINZIONI







HORTAPLAST 50x100

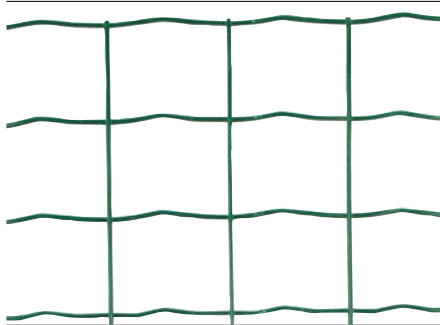

Articolo		 Ø mm	 cm	 ml	 kg rotolo	 rotoli per bancale	€ rotolo
3EP50100060	50x100	2,50	60	25	12,80	12	71,44
3EP50100080	50x100	2,50	80	25	16,80	12	91,13
3EP50100100	50x100	2,50	100	25	20,40	12	109,30
3EP50100120	50x100	2,50	120	25	24,20	12	129,28
3EP50100150	50x100	2,50	150	25	29,50	12	159,23
3EP50100180	50x100	2,50	180	25	34,60	12	189,18
3EP50100200	50x100	2,50	200	25	38,00	12	209,14







MULTIPLAST 50x60

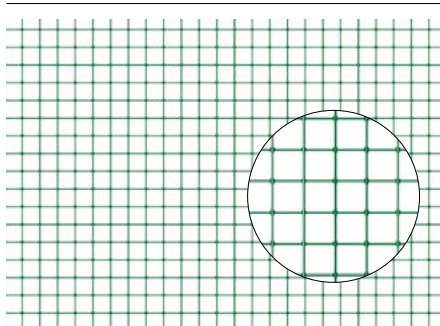

Articolo		 Ø mm	 cm	 ml	 kg rotolo	 rotoli per bancale	€ rotolo
3EP5060100	50x60	3,00	100	25	38,00	9	205,79
3EP5060120	50x60	3,00	120	25	45,60	9	246,95
3EP5060150	50x60	3,00	150	25	67,00	9	308,67
3EP5060180	50x60	3,00	180	25	68,40	9	370,42
3EP5060200	50x60	3,00	200	25	76,00	9	411,58
3EP5060220	50x60	3,00	220	25	83,60	9	475,37
3EP5060250	50x60	3,00	250	25	95,00	9	540,18







VOLIPLAST 13x13

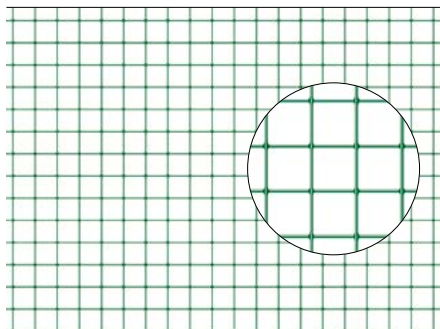

Articolo		 Ø mm	 cm	 ml	 kg rotolo	 rotoli per bancale	€ rotolo
3EP1313050	13x13	1,20	50	25	9,40	20	64,48
3EP1313060	13x13	1,20	60	25	11,30	20	76,63
3EP1313080	13x13	1,20	80	25	15,00	20	101,20
3EP1313100	13x13	1,20	100	25	18,80	20	124,01
3EP1313120	13x13	1,20	120	25	22,50	20	148,81
3EP1313150	13x13	1,20	150	25	28,10	20	186,00
3EP1313200	13x13	1,20	200	25	37,50	20	273,43







VOLIPLAST 16x16

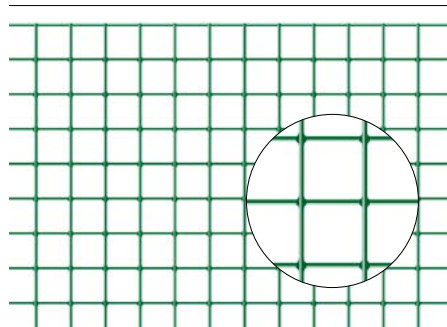

Articolo		 Ø mm	 cm	 ml	 kg rotolo	 rotoli per bancale	€ rotolo
3EP1616050	16x16	1,20	50	25	7,80	20	55,72
3EP1616060	16x16	1,20	60	25	9,30	20	66,24
3EP1616100	16x16	1,20	100	25	15,50	20	107,16
3EP1616120	16x16	1,20	120	25	18,60	20	128,60
3EP1616150	16x16	1,20	150	25	23,30	20	160,76







VOLIPLAST 25x25

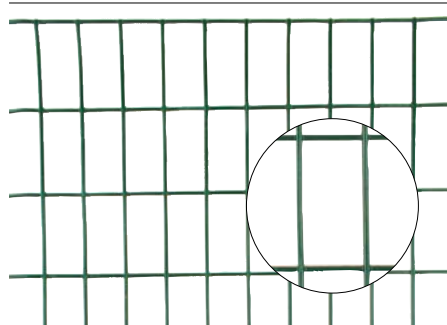

Articolo		 Ø mm	 cm	 ml	 kg rotolo	 rotoli per bancale	€ rotolo
3EP2525100	25x25	2,30	100	25	40,00	9	233,03
3EP2525150	25x25	2,30	150	25	60,00	9	349,55







VOLIPLAST 50x25

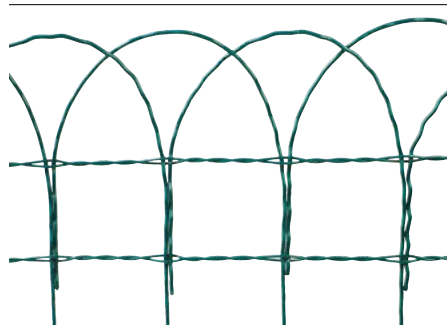

Articolo		 Ø mm	 cm	 ml	 kg rotolo	 rotoli per bancale	€ rotolo
3EP5025100	50x25	2,60	100	25	38,50	9	233,61
3EP5025120	50x25	2,60	120	25	46,50	9	280,33
3EP5025150	50x25	2,60	150	25	58,00	9	350,41
3EP5025180	50x25	2,60	180	25	69,50	9	420,49
3EP5025200	50x25	2,60	200	25	77,00	9	467,21

BORDERPLAST 85x150









Articolo		 Ø mm	 cm	 ml	 kg rotolo	 rotoli per bancale	€ rotolo
3ROP040	85x150	2,10/3,10	40	25	9,00	18	71,38
3ROP065	85x150	2,10/3,10	65	25	14,00	18	85,75
3ROP090	85x150	2,10/3,10	90	25	19,00	9	114,75
3ROPH04010	85x150	2,10/3,10	40	10	3,60	-	31,80
3ROPH06510	85x150	2,10/3,10	65	10	5,60	-	41,40

Ø filo orizzontale: 1,50/2,10 mm - Ø filo verticale: 2,10/3,10 mm

MULTINET 50x75







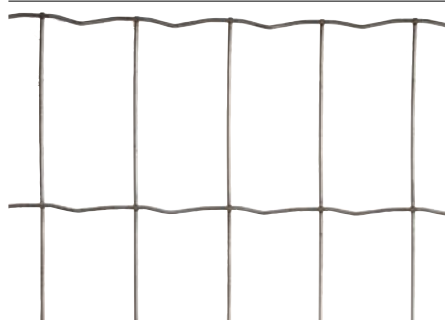

Articolo		 Ø mm	 cm	 ml	 kg rotolo	 rotoli per bancale	€ rotolo
3EZ5075080	50x75	1,90	80	25	15,00	12	31,25
3EZ5075100	50x75	1,90	100	25	19,00	12	75,82
3EZ5075120	50x75	1,90	125	25	23,50	12	94,76
3EZ5075150	50x75	1,90	150	25	28,00	12	113,72
3EZ5075180	50x75	1,90	175	25	32,50	12	132,67
3EZ5075200	50x75	1,90	200	25	37,50	12	151,63

Zincata prima della saldatura - Certificata anticaduta

MULTIFORT 50x100







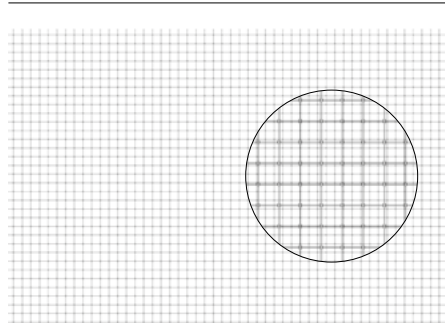

Articolo		 Ø mm	 cm	 ml	 kg rotolo	 rotoli per bancale	€ rotolo
3EZ50100100	50x100	2,60	100	25	32,00	9	149,37
3EZ50100120	50x100	2,60	120	25	38,00	9	179,26
3EZ50100150	50x100	2,60	150	25	48,00	9	224,06
3EZ50100180	50x100	2,60	180	25	57,50	9	268,89
3EZ50100200	50x100	2,60	200	25	64,00	9	298,75

Zincata prima della saldatura







VOLIFORT 6x6 ZINCATA DOPO

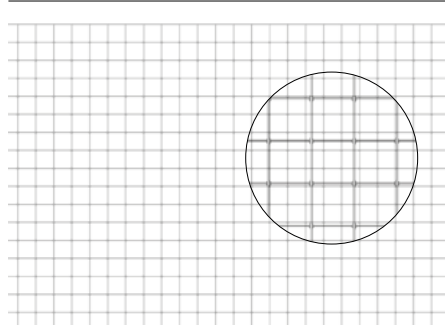

Articolo		 Ø mm	 cm	 ml	 kg rotolo	 rotoli per bancale	€ rotolo
3EZD66050	6x6	0,65	50	25	11,80	20	133,49
3EZD66100	6x6	0,65	100	25	23,50	20	256,71







VOLIFORT 13x13 ZINCATA DOPO

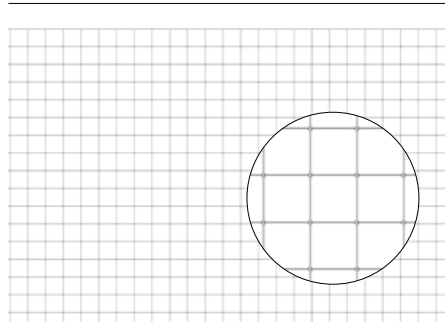

Articolo		 Ø mm	 cm	 ml	 kg rotolo	 rotoli per bancale	€ rotolo
3EZD1313050	13x13	0,90	50	25	9,60	20	83,06
3EZD1313060	13x13	0,90	60	25	11,60	20	98,71
3EZD1313080	13x13	0,90	80	25	15,40	20	130,33
3EZD1313100	13x13	0,90	100	25	19,30	20	159,73
3EZD1313120	13x13	0,90	120	25	23,10	20	191,67
3EZD1313150	13x13	0,90	150	25	28,90	20	239,59







VOLIFORT 16x16 ZINCATA DOPO

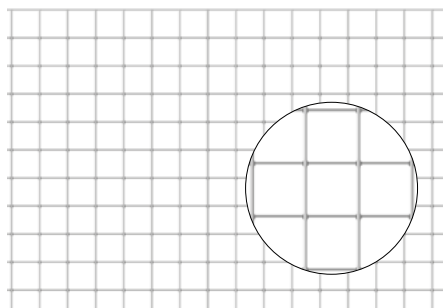

Articolo		 Ø mm	 cm	 ml	 kg rotolo	 rotoli per bancale	€ rotolo
3EZD1616100	16x16	0,90	100	25	16,00	20	145,61
3EZD1616150	16x16	0,90	150	25	24,00	20	218,41







VOLIFORT 19x19 ZINCATA DOPO

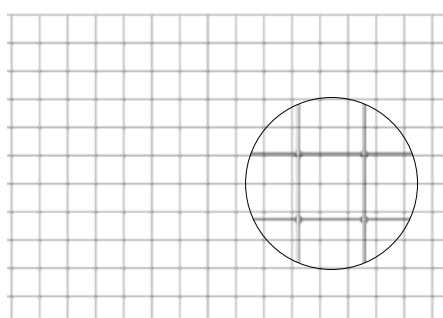

Articolo		 Ø mm	 cm	 ml	 kg rotolo	 rotoli per bancale	€ rotolo
3EZD1919100	19x19	1,45	100	25	36,80	14	258,63
3EZD1919150	19x19	1,45	150	25	55,10	14	387,93





VOLIFORT 25x25 ZINCATA DOPO



Articolo		 Ø mm	 cm	 ml	 kg rotolo	 rotoli per bancale	€ rotolo
3EZD2525100	25x25	1,75	100	25	39,00	12	261,26
3EZD2525120	25x25	1,75	120	25	46,80	12	313,51





FLYNET 13x13 ZINCATA PRIMA

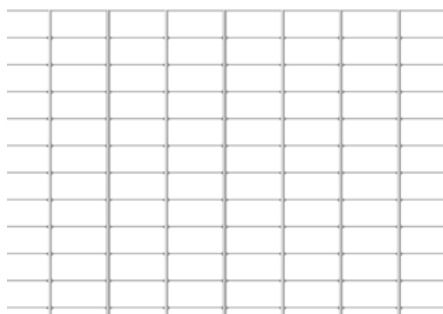

Articolo		 Ø mm	 cm	 ml	 kg rotolo	€ rotolo
3EZP1212H050	13x13	1,40	50	25	23,50	109,03
3EZP1212H060	13x13	1,40	60	25	28,00	130,83
3EZP1212H080	13x13	1,40	80	25	37,50	174,45
3EZP1212H100	13x13	1,40	100	25	46,50	218,05
3EZP1212H150	13x13	1,40	150	25	70,00	327,08

FLYNET 13x25 ZINCATA PRIMA





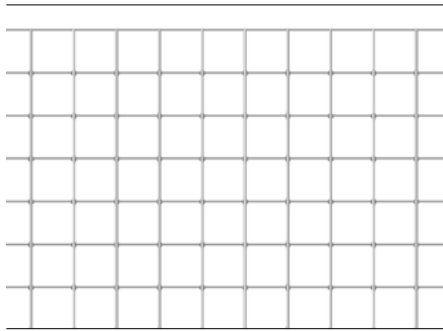

Articolo		 Ø mm	 cm	 ml	 kg rotolo	€ rotolo
3EZP1225H050	13x25	1,40	50	25	17,50	81,38
3EZP1225H060	13x25	1,40	60	25	21,00	97,65
3EZP1225H080	13x25	1,40	80	25	28,00	130,21
3EZP1225H100	13x25	1,40	100	25	35,00	162,77
3EZP1225H150	13x25	1,40	150	25	52,50	244,13

RECINZIONI





FLYNET 19x19 ZINCATA PRIMA

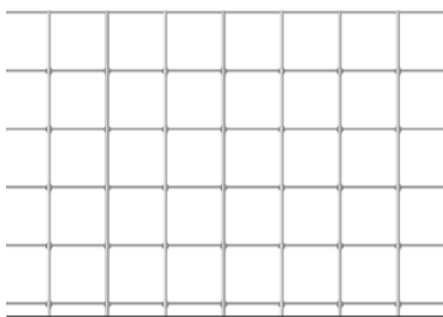

Articolo		 Ø mm	 cm	 ml	 kg rotolo	€ rotolo
3EZP1919H050	19x19	1,40	50	25	15,50	73,16
3EZP1919H060	19x19	1,40	60	25	19,00	87,80
3EZP1919H080	19x19	1,40	80	25	25,00	117,06
3EZP1919H100	19x19	1,40	100	25	31,00	146,32
3EZP1919H150	19x19	1,40	150	25	46,50	219,50





FLYNET 25x25 ZINCATA PRIMA

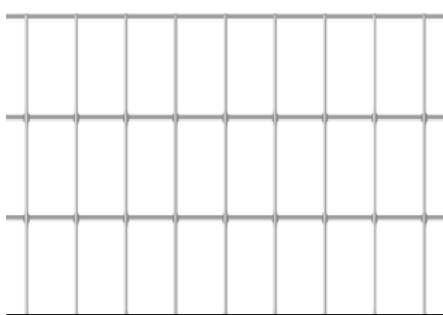

Articolo		 Ø mm	 cm	 ml	 kg rotolo	€ rotolo
3EZP2525H100	25x25	1,60	100	25	30	151,55





FLYNET 50x25 ZINCATA PRIMA

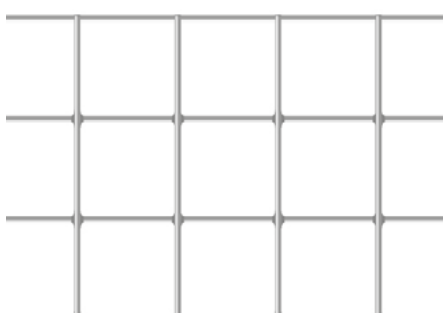

Articolo		 Ø mm	 cm	 ml	 kg rotolo	€ rotolo
3EZP2550H100	50x25	1,90	100	25	33,00	158,50
3EZP2550H120	50x25	1,90	120	25	39,50	190,22
3EZP2550H150	50x25	1,90	150	25	49,50	237,76
3EZP2550H200	50x25	1,90	200	25	65,50	317,03







FLYNET 50x50 ZINCATA PRIMA

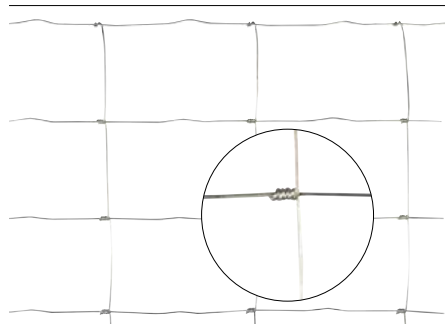

Articolo		 Ø mm	 cm	 ml	 kg rotolo	€ rotolo
3EZP5050H100	50x50	1,90	100	25	22,00	103,34
3EZP5050H120	50x50	1,90	120	25	26,50	124,00
3EZP5050H150	50x50	1,90	150	25	33,00	155,00
3EZP5050H180	50x50	1,90	180	25	39,50	185,99
3EZP5050H200	50x50	1,90	200	25	44,00	206,67

AGRINET 150







Articolo		 Ø mm	 cm	 ml	 kg rotolo	 rotoli per bancale	€ rotolo
3PAS100	150	1,90/2,20	100	50	18,40	20	72,95
3PAS120	150	1,90/2,20	120	50	22,10	20	87,91
3PAS140	150	1,90/2,20	140	50	29,40	20	108,34
3PAS150	150	1,90/2,50	145	50	36,80	14	141,71
3PAS200	150	1,90/2,50	200	50	44,10	14	172,33

cm				
20,32				
20,32	cm			
15,24	15,24			
15,24	10,16			
10,16	10,16			
10,16	10,16			
10,16	10,16			
10,16	10,16	cm		
10,16	10,16	20,32		
10,16	10,16	20,32		
10,16	10,16	15,24	cm	
10,16	10,16	15,24	20,32	cm
10,16	10,16	10,16	20,32	20,32
10,16	5,08	10,16	20,32	20,32
5,08	5,08	10,16	15,24	15,24
5,08	5,08	10,16	15,24	15,24
5,08	5,08	10,16	10,16	10,16
5,08	5,08	10,16	10,16	10,16
5,08	5,08	10,16	10,16	10,16
200/20/15	150/18/15	140/12/15	120/9/15	100/8/15

PALI PLASTICATI LEGGERI VERDI



Articolo	 Sezione	 cm	 kg pz.	 Pz. fascio	€ cad.
3PLP100	30x30x3,50	100	1,45	10	5,70
3PLP125	30x30x3,50	125	1,80	10	7,22
3PLP150	30x30x3,50	150	2,20	10	8,65
3PLP175	30x30x3,50	175	2,55	10	10,08
3PLP200	35x35x4,00	200	3,60	5	14,89
3PLP225	35x35x4,00	225	4,10	5	16,80
3PLP250	35x35x4,00	250	4,50	5	18,66
3PLP300	35x35x4,00	300	5,50	5	22,40

Piastra a 2 fori 60x140 mm saldata al piede del palo + € 14,00 netto

Piastra a 4 fori 80x140 mm saldata al piede del palo + € 16,00 netto

* Idonea per rete H max 150

PALI PLASTICATI LEGGERI ANTRACITE

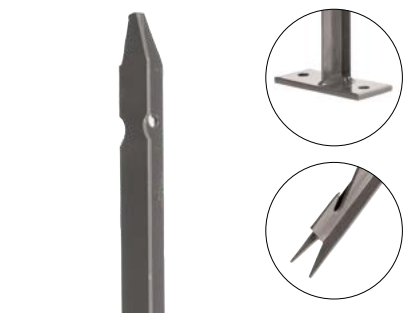

Articolo	T Sezione	↑ cm	kg pz.	Pz. fascio	€ cad.
3PLPA125	30x30x3,50	120	1,80	10	7,93
3PLPA150	30x30x3,50	150	2,20	10	9,52
3PLPA175	30x30x3,50	175	2,55	10	11,08
3PLPA200	35x35x4,00	200	3,60	5	16,41
3PLPA225	35x35x4,00	225	4,10	5	18,48
3PLPA250	35x35x4,00	250	4,50	5	20,52
Piastra a 2 fori 60x140 mm saldata al piede del palo					+ € 14,00 netto
Piastra a 4 fori 80x140 mm saldata al piede del palo					+ € 16,00 netto

* Idonea per rete H max 150

PALI PLASTICATI PESANTI



Articolo	T Sezione	↑ cm	kg pz.	Pz. fascio	€ cad.
3PPN130	30x30x5,00	130	2,66	10	10,90
3PPN160	30x30x5,00	160	3,35	10	13,79
3PPN182	30x30x5,00	182	3,80	10	15,59
3PPN206	35x35x5,50	206	5,80	5	23,80
3PPN235	35x35x5,50	235	6,50	5	26,67
3PPN255	35x35x5,50	255	7,10	5	29,21
3PPN295	40x40x4,50	300	7,60	5	31,03

SAETTE PLASTICATE VERDI



Articolo	Per pali h	L Sezione	↑ cm	kg pz.	Pz. fascio	€ cad.
3SP120	100-125-150	25x25	120	1,20	10	6,15
3SP150	175	25x25	150	1,50	10	7,66
3SP200	200-225-250	25x25	200	2,00	10	10,29



Articolo	Per pali h	T Sezione	↑ cm	kg pz.	Pz. fascio	€ cad.
3SPT200	200-225-250	30x3,5	200	2,64	10	18,00
3SPT225	225-250-300	30x3,5	225	3,52	10	20,30

SAETTE PLASTICATE ANTRACITE

Articolo	Per pali h	L Sezione	↑ cm	kg pz.	Pz. fascio	€ cad.
3SPA120	100-125-150	25x25	120	1,20	10	6,77
3SPA150	175	25x25	150	1,50	10	8,44
3SPA200	200-225-250	25x25	200	2,00	10	11,30



PALI ZINCATI LEGGERI

Articolo	T Sezione	↑ cm	kg pz.	Pz. fascio	€ cad.
3PLZ100	30x30x3,50	100	1,45	10	7,52
3PLZ125	30x30x3,50	125	1,80	10	10,30
3PLZ150	30x30x3,50	150	2,20	10	11,31
3PLZ175	30x30x3,50	175	2,55	10	13,19
3PLZ200	35x35x4,00	200	3,60	5	19,67
3PLZ225	35x35x4,00	225	4,10	5	22,06
3PLZ250	35x35x4,00	250	4,50	5	24,54
3PLZ300	35x35x4,00	300	5,50	5	29,53



PALI ZINCATI PESANTI

Articolo	T Sezione	↑ cm	kg pz.	Pz. fascio	€ cad.
3PPZN130	30x30x5,00	130	2,66	10	13,92
3PPZN160	30x30x5,00	160	3,35	10	17,42
3PPZN182	30x30x5,00	182	3,80	10	19,80
3PPZN206	35x35x5,50	206	5,80	5	30,30
3PPZN235	35x35x5,50	235	6,50	5	33,94
3PPZN255	35x35x5,50	255	7,10	5	37,13
3PPZN295	40x40x4,50	300	7,60	5	40,55



SAETTE ZINCATE

Articolo	Per pali h	L Sezione	↑ cm	kg pz.	Pz. fascio	€ cad.
3SZ120	100-125-150	25x25	120	1,20	10	7,86
3SZ150	175	25x25	150	1,50	10	9,85
3SZ200	200-225-250	25x25	200	2,00	10	13,09

Articolo	Per pali h	T Sezione	↑ cm	Pz. fascio	€ cad.
3SZT200	200-225-250	30x3,5	200	10	22,46
3SZT225	225-250-300	30x3,5	225	10	25,36

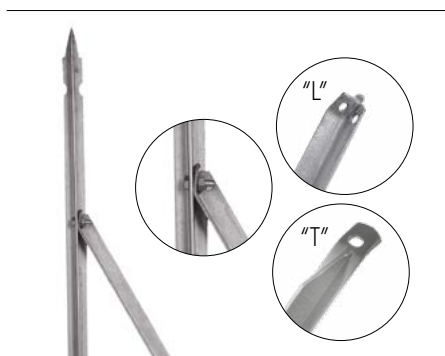

RECINZIONI

DADI E BULLONI ZINCATI PER SAETTE INOX



Articolo	Misura	Confezione	€ cad.
3BULLINOX	8x25	10	0,495

PALI A T A SBALZO

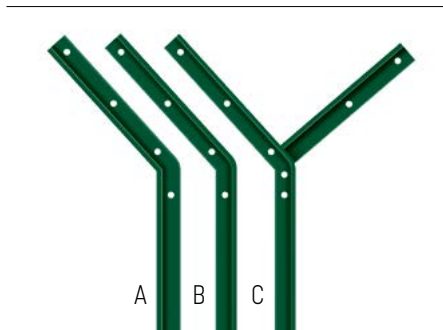

Descrizione	T Sezione	€ cad.
Pali a T pesanti plasticati a sbalzo	40-50	su richiesta
Pali a T pesanti zincati a sbalzo	40-50	su richiesta

PALI A TUBO PLASTICATI CON PASSAFILO IN PLASTICA



Articolo	Ø mm	T Sezione		€ cad.
		cm	Passafili	
3PTPP34120	34	120	3	11,27
3PTPP34150	34	150	3	13,91
3PTPP38175	38	175	3	17,87
3PTPP38200	38	200	3	20,47
3PTPP48200	48	200	3	25,47
3PTPP48230	48	230	3	29,27
3PTPP48260	48	260	4	33,16
3PTPP48300	48	300	6	38,17

SAETTE PLASTICATE PER PALI A TUBO CON PASSAFILO IN PLASTICA



Articolo	Ø mm	cm	€ cad.
3SPTP34120	34	120	11,83
3SPTP34150	34	150	14,55
3SPTP38175	38	175	18,71
3SPTP38200	38	200	21,42
3SPTP48200	48	200	26,68
3SPTP48260	48	260	34,74

COLLARI PLASTICATI PER SAETTE



Articolo	 \emptyset mm	€ cad.
3COLLP34	34	1,84
3COLLP38	38	2,03
3COLLP48	48	2,24
3COLLP60	60	2,37



COLLARI ZINCATI A CALDO PER SAETTE A TUBO



Articolo	 \emptyset mm		€ cad.
3COLLZ48	48	2,593	2,463
3COLLZ60	60	4,004	4,180

CANCELLI PEDONALI "GREEN" VERDI





Articolo	 cm	 cm	 Piantane	€ cad.
3CSP1000X1000	100	100	60x60	272,48
3CSP1000X1250	100	125	60x60	292,24
3CSP1000X1500	100	150	60x60	307,84
3CSP1000X1750	100	175	60x60	340,08
3CSP1000X2000	100	200	60x60	362,96

Telaio  35/40 mm - Rete elettrosaldata $\#$ 50x50 mm \emptyset 4 mm

CANCELLI PEDONALI "GREEN" ANTRACITE



Articolo	 cm	 cm	 Piantane	€ cad.
3CSAP1000X1000	100	100	60x60	349,92
3CSAP1000X1250	100	125	60x60	371,52
3CSAP1000X1500	100	150	60x60	392,04
3CSAP1000X1750	100	175	60x60	428,76
3CSAP1000X2000	100	200	60x60	567,57

Telaio  35/40 mm - Rete elettrosaldata $\#$ 50x200 mm \emptyset 5 mm

CANCELLI DOPPI "GREEN"

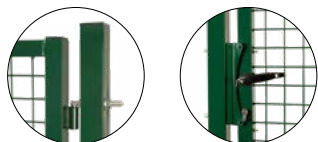

Articolo	cm	cm	Piantane	€ cad.
3CDP3000X1000	300	100	100x100	887,12
3CDP3000X1250	300	125	100x100	985,92
3CDP3000X1500	300	150	100x100	1.073,28
3CDP3000X1750	300	175	100x100	1.172,08
3CDP3000X2000	300	200	100x100	1.277,12
3CDP4000X1500	400	150	100x100	1.403,35
3CDP4000X1750	400	175	100x100	1.542,58
3CDP4000X2000	400	200	100x100	1.687,34

Telaio 35/40 mm - Rete elettrosaldata 50x50 mm Ø 4 mm

CANCELLI PEDONALI ZINCATI

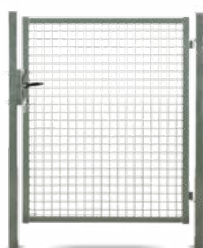

Articolo	cm	cm	Piantane	€ cad.
3CSZ1000X1000	100	100	60x60	479,52
3CSZ1000X1250	100	125	60x60	539,31
3CSZ1000X1500	100	150	60x60	586,44
3CSZ1000X1750	100	125	60x60	696,71
3CSZ1000X2000	100	200	60x60	719,28

Telaio 35/40 mm - Rete elettrosaldata 50x50 mm Ø 4 mm

PASTRA ZINCATATA E PLASTICATA

Articolo		Piantane	€ cad.
3GSZPQ60	zincata	60x60	18,57
3GSPPQ60	plasticata	60x60	23,86

KIT SERRATURA

Articolo		€ cad.
3CSPKIT	per cancello singolo plasticato	120,96
3CDPKIT	per cancello doppio plasticato	324,00

PANNELLO "GREEN" VERDE



Articolo	cm	cm	Sezione rete	Ø mm	Nervature	€ cad.
3GPAN50620	200	62	50x200	5	2	30,43
3GPAN50820	200	82	50x200	5	2	38,41
3GPAN51020	200	102	50x200	5	2	44,76
3GPAN51220	200	122	50x200	5	2	50,80
3GPAN51420	200	142	50x200	5	2	56,85
3GPAN51720	200	172	50x200	5	3	69,97
3GPAN51920	200	192	50x200	5	3	76,48

PANNELLO "GREEN" ANTRACITE

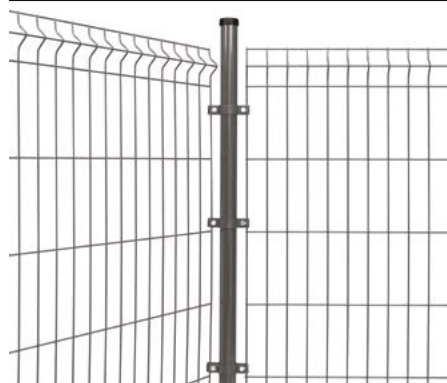

Articolo	→ cm	↑ cm	# Sezione rete	← Ø mm	Nervature	€ cad.
3GPANA51030	200	102	50x200	5	2	47,00
3GPANA51230	200	122	50x200	5	2	53,36
3GPANA51430	200	142	50x200	5	2	59,73
3GPANA51730	200	172	50x200	5	3	73,56
3GPANA51930	200	192	50x200	5	3	80,39

PALI A TUBO PER PANNELLO "GREEN" VERDE



Articolo	↑ cm	← Ø mm	↑ cm*	↑ cm**	Collari o ganci consigliati	€ cad.
3GPADSR1100	110	48	62-82	102	3	13,23
3GPADSR1300	130	48	102	122	3	15,62
3GPADSR1500	150	48	122	142	3	18,04
3GPADSR1800	180	48	142	172	3	20,65
3GPADSR2000	200	48	172	192	4	22,90
3GPADSR2300	230	48	192	-	4	26,29
3GPADSR2600	260	48	192	-	4	29,79

* Altezza del pannello con pali posati nel muretto o nel terreno

** Altezza del pannello con pali posati usando piastra di supporto

Articolo	Descrizione	€ cad.
A - 3GCOLPS	Collari plasticati semplici Ø 48 mm + bullone	2,76
B - 3GCOLPD	Collari plasticati doppi Ø 48 mm + bullone	3,96
C - 3GFPN	Gancio di fissaggio in plastica nero per pali a tubo + viti	2,07
D - 3GSZPT	Piastra zincata di supporto per pali a tubo Ø 48 mm	14,50
D1 - 3GSPPT	Piastra plasticata di supporto per pali a tubo Ø 48 mm	18,46
E - 3GBEZ	Bulloni ad espansione per piastra supporto pali	1,91

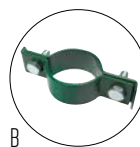

PALI A TUBO PER PANNELLO "GREEN" ANTRACITE



Articolo	↑ cm	↖ mm	↑ cm*	↑ cm**	Collari o ganci consigliati	€ cad.
3GPADSRA1100	110	48	62-82	102	3	13,88
3GPADSRA1300	130	48	102	122	3	16,40
3GPADSRA1500	150	48	122	142	3	18,94
3GPADSRA1750	175	48	142	172	3	21,65
3GPADSRA2000	200	48	172	192	4	24,02
3GPADSRA2300	230	48	192	-	4	27,60
3GPADSRA2600	260	48	192	-	4	31,27

* Altezza del pannello con pali posati nel muretto o nel terreno

** Altezza del pannello con pali posati usando piastra di supporto

Articolo	Descrizione	€ cad.
A - 3GCOLAS	Collari plasticati semplici Ø 48 mm + bullone	3,04
B - 3GCOLAD	Collari plasticati doppi Ø 48 mm + bullone	4,34
C - 3GFPN	Gancio di fissaggio in plastica nero per pali a tubo + viti	2,07
D - 3GSZPT	Piastra zincata di supporto per pali a tubo Ø 48 mm	14,50
E - 3GBEZ	Bulloni ad espansione per piastra supporto pali	1,91

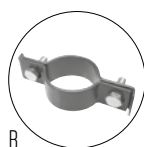

BARRE DI TENSIONE TONDINO ZINCATO



Articolo	↖ mm	↔ cm	≡ Pz. fascio	€ cad.
3TOND105	8	105	10	2,48
3TOND130	8	130	10	3,11
3TOND155	8	155	10	3,68
3TOND180	8	180	10	4,26
3TOND205	8	205	10	4,87

BARRE DI TENSIONE TONDINO PLASTICATO

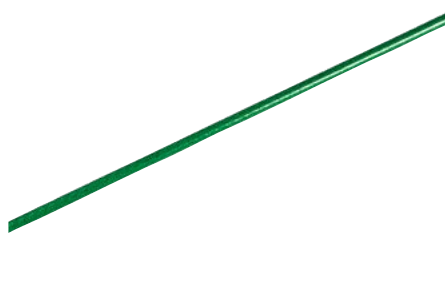

Articolo	↖ mm	↔ cm	≡ Pz. fascio	€ cad.
3TONDP105	7	105	10	2,08
3TONDP130	7	130	10	2,57
3TONDP155	7	155	10	3,08
3TONDP180	7	180	10	3,54
3TONDP205	7	205	10	4,07

RECINZIONI

PALI A TUBO QUADRO PER PANNELLO "GREEN" VERDE



Articolo	↑ cm	Sezione	↑ cm*	↑ cm**	Collari o ganci consigliati	€ cad.
3GPADSQ1100	110	50x50	62-82	102	3	18,40
3GPADSQ1300	130	50x50	102	122	3	21,11
3GPADSQ1500	150	50x50	122	142	3	24,37
3GPADSQ1800	180	50x50	142	172	3	28,63
3GPADSQ2000	200	50x50	172	192	4	31,53
3GPADSQ2300	230	50x50	192	-	4	36,27

* Altezza del pannello con pali posati nel muretto o nel terreno

** Altezza del pannello con pali posati usando piastra di supporto

Articolo	Descrizione	€ cad.
A - 3GCOLQPS	Collari plasticati semplici Ø 50 mm + bullone	5,06
B - 3GCOLQPD	Collari plasticati doppi Ø 50 mm + bullone	5,48
C - 3GFPNQ	Gancio di fissaggio in pvc nero per pali quadri + viti	2,07
D - 3GSZPQ	Piastra zincata di supporto per pali quadri 50x50 mm	13,63
D1-3GSPPQ	Piastra plasticata di supporto per pali quadri 50x50 mm	17,36
E - 3GBEZ	Bulloni ad espansione per piastra supporto pali	1,91

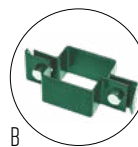
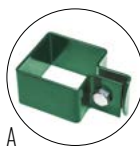

PALI A TUBO QUADRO PER PANNELLO "GREEN" ANTRACITE



Articolo	↑ cm	Sezione	↑ cm*	↑ cm**	Collari o ganci consigliati	€ cad.
3GPADSQA1100	110	50x50	62-82	102	3	19,31
3GPADSQA1300	130	50x50	102	122	3	22,15
3GPADSQA1500	150	50x50	122	142	3	25,55
3GPADSQA1800	180	50x50	142	172	3	30,08
3GPADSQA2000	200	50x50	172	192	4	33,11
3GPADSQA2300	230	50x50	192	-	4	38,12

* Altezza del pannello con pali posati nel muretto o nel terreno

** Altezza del pannello con pali posati usando piastra di supporto

Articolo	Descrizione	€ cad.
A - 3GCOLQAS	Collari plasticati semplici Ø 50 mm + bullone	5,56
B - 3GCOLQAD	Collari plasticati doppi Ø 50 mm + bullone	6,03
C - 3GFPNQ	Gancio di fissaggio in pvc nero per pali quadri + viti	2,07
D - 3GSZPQ	Piastra zincata di supporto per pali quadri 50x50 mm	13,63
E - 3GBEZ	Bulloni ad espansione per piastra supporto pali	1,91

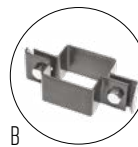
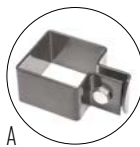

RECINZIONI

TENDIFILO



Articolo	→ cm	📦 Pz. scatola	€ cad.
3TP100 plasticati verde	10	100	1,000
3TPA100 plasticati antracite	10	100	1,212
3TZ100 zincati	10	100	1,040

FILO SPINATO



Articolo	📏 Ø mm	N° punte	Distanze punte cm	→ ml	🏋️ kg pz.	€ cad.
3FSZ zincato	1,70	4	10	100	5,10	40,50
3FSP plasticato	2,20/2,80	4	10	100	10	42,10

Prodotto con fili d'acciaio ad alta resistenza con carico di rottura pari a 440 kg min. (equivalente a quello di un filo di acciaio dolce Ø 2,70).
Confezionato in scatole di cartone.

CONDIZIONI GENERALI DI VENDITA

I prezzi del presente listino non sono impegnativi, in quanto possono variare in qualsiasi momento e senza preavviso, secondo il costo della mano d'opera e le oscillazioni di prezzo delle materie prime.

I pagamenti dovranno essere effettuati nei termini e nelle condizioni stabilite al momento dell'ordine. In caso di mancato rispetto delle scadenze riportate in fattura, il cliente accetta interessi pari al tasso ufficiale "BCE" maggiorato di 8 punti percentuali (riferimento decreto N. 231/2002 e successive modifiche) più eventuali spese bancarie.

In caso di mancato pagamento di una fattura, previa messa in mora rimasta senza effetto oltre i termini di 5 giorni, la società si riserva il diritto di sospendere tutte le consegne in corso o future.

Le caratteristiche dei prodotti elencati, così come i pesi e dimensioni, sono da ritenersi puramente indicativi e soggetti a tolleranze di produzione; possono subire variazioni e migliorie senza preavviso e senza che ciò possa essere oggetto di reclamo e/o variazione di prezzo.

La merce viaggia sempre a rischio e pericolo dell'acquirente, anche se venduta in porto franco. I prodotti devono essere controllati dal cliente al momento della consegna. Qualsiasi reclamo o contestazione riguardante difetti o mancanze, deve essere comunicata entro 5 giorni dalla data di consegna. I resi, in ogni caso, dovranno essere autorizzati e accompagnati da documento di trasporto. In caso di controversia il Foro competente è sempre quello di Lecco.

CONDIZIONI GENERALI DI CONSEGNA

I prezzi sono intesi franco nostra fabbrica. La società si impegna a rispettare i tempi di consegna indicati nell'ordine, salvo forza maggiore e in caso di circostanze al di fuori del suo controllo (rottura di macchinari, difficoltà di approvvigionamenti, scioperi interni, scioperi degli autotrasportatori, situazioni climatiche impreviste, etc.) senza che questo sia motivo di annullamento degli ordini e richiesta di penalità.

PER CONSEGNARE CON NOSTRI MEZZI O VETTORI

Regione: Lombardia - Piemonte

Addebito in fattura di una percentuale pari al **4%** dell'imponibile, nel caso tale percentuale non raggiungesse la tariffa minima di **€ 40**, in fattura sarà addebitata quest'ultima.

MINIMO FATTURABILE

Regione: Lombardia - Piemonte

Il minimo fatturabile mensile è di **€ 500,00** (imponibile). Per fatturazioni inferiori a tale importo lo sconto base sarà diminuito del 5%.

Regione: tutte le restanti

Il minimo fatturabile è di **€ 1.000,00** (imponibile). Il costo del trasporto è variabile in funzione dell'imponibile.

TRAFILERIE VAVASSORI srl

via Prada, 21
23883 Beverate di Brivio (LC)
ITALY

T **+39 039 5320800**

F +39 039 5320583

commerciale@trafilerievavassori.it

www.trafilerievavassori.it